



**Custom Products & Services, Inc.**

**6140 Claude Way E.**

**Inver Grove Heights, MN. 55076**

PH: 888-444-1202 (Toll Free) or 651-452-0113 FAX: 651-452-2264

E-MAIL: [info@custom-products.com](mailto:info@custom-products.com)

WEBSITE: [www.custom-products.com](http://www.custom-products.com)

*"Your source for workplace solutions"*

# ORDER GUIDE

## POLE MOUNTS

**FOR LCD DISPLAYS, KEYBOARDS,  
LAPTOPS, CPU's**

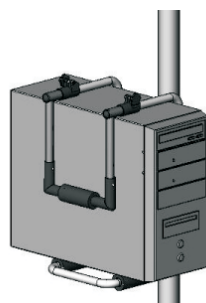

# Configurations

---

## POLE MOUNT SERIES



**#60250 mobile cart**



**Pole mount LCD/KB holder**

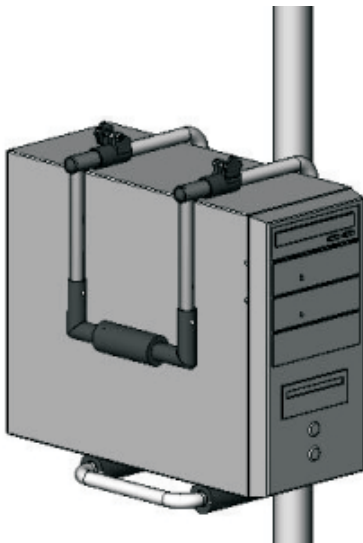







**Pole mount CPU holder**







**#60251 mobile cart**

# Configurations

Configurations	Part Selections	Part Numbers	Descriptions
	1a. Pivot head	#21-01	VESA 75 pivot bracket
		#21-01H	Heavy duty pivot bracket (VESA 75)
	1b. Options	#21-13	LCD/Keyboard holder (excluding keyboard tray)
		#21-14	Fold up tray pivot unit
Standard Keyboard (left) Clamp-Style Keyboard (Right)	2. Pole	#23-22	Dia. 2" pole x 16" long
		#23-23	Dia. 2" pole x 32" long
		#23-24	Dia. 2" pole x 48" long
		#23-72	Dia. 2" pole x 72" long
		#23-26	2"/1.5" telescopic pole (33-1/2" - 55", Ceiling Mount)
		Adjustable LCD	#25-40Q
#25-42Q	Quick release 1.5" single mount pole clamp		
	4. Mounting base	#25-24	Die cast grommet for 1.5" telescoping pole
Standard Laptop Platform (left) Clamp-Style Laptop Platform (right)		#25-33	Round base for 2" pole (Excluding screws)
		#25-35	Heavy Duty round base for 2" pole (Screws are not included)
	5. Platforms	#24-06	Clamp-Style Laptop Platform + optional mouse tray
		#24-07	Clamp-Style Keyboard Platform + Mouse Tray + gel wrist rest
		#24-21	Laptop platform, (15" W x 12" D)
		#24-31P	Phenolic Keyboard platform + mouse tray + gel wrist rest
	6. Swing arm	#22-06-1	Die cast Extension arm (6 1/2" L)
		7. Adjustable arm	#22-04-3
#22-04-5	Adjustable arm, 15" L. Wt. capacity: 16-28 lbs.		
#26-31-52	Arm reach, 39 3/8" L. Wt. capacity: 2-11 lbs.		

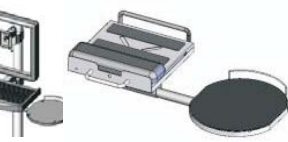
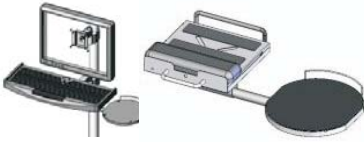
# Configurations

Configurations	Part Selections	Part Numbers	Descriptions	
<b>Pole mount extension arm series</b> 	1a. Pivot head	#21-01	VESA 75 pivot bracket	
		#21-01H	Heavy duty pivot bracket, (VESA 75)	
<b>Extended LCD</b> 	1b. Options	#21-13	LCD/Keyboard holder (excluding keyboard tray)	
		#21-14	Fold up tray pivot unit	
<b>Dual arm LCD mount</b> 	2. Pole	#23-22	Dia. 2" pole 16" long	
		#23-23	Dia. 2" pole x 32" long	
		#23-24	Dia. 2" pole x 48" long	
		#23-25	Dia. 2" pole x 72" long	
		#23-26	2"/1.5" telescopic pole, (33.5-55" L, Ceiling Mount)	
		#25-40Q	Quick release 2" single mount pole clamp	
<b>Standard Keyboard (left) Keyboard Clamp (right)</b> 	3. Pole clamp	#25-42Q	Quick release 1.5" single mount pole clamp	
		4. Mounting base	#25-24	Die casting grommet for 23-13 telescoping pole
			#25-33	Round base for 2" pole (Excluding screws)
#25-35	Heavy Duty round base for 2" pole (Screws are not included)			
<b>Extended dual swing arm</b> 	5. Platform	#24-06	Clamp-Style Laptop Platform + optional mouse tray	
		#24-07	Clamp-Style Keyboard Platform + Mouse Tray + gel wrist rest	
		#24-21	Laptop platform, (15" W x 12" D)	
		#24-31P	Phenolic Keyboard platform + mouse tray + gel wrist rest	
<b>Mount Close to pole</b>				
<b>Single LCD</b> 	1. Tilt Pivot	#21-01	VESA 75mm pivot bracket	
		#21-01H	Heavy duty pivot bracket (VESA 75mm)	

# Part information

Parts	Part Numbers	Description
-------	--------------	-------------



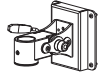
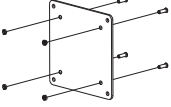
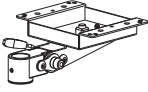

## Tilt Pivot Head

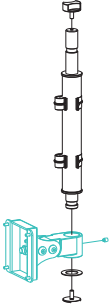
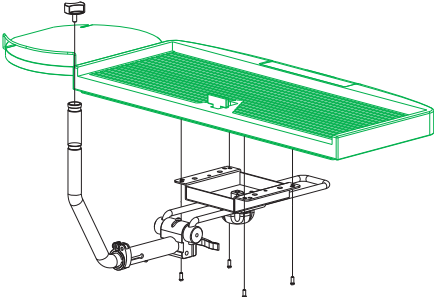
		#21-01 VESA 75 pivot bracket (max. load up to 24 lbs)
#21-01	#21-01H	#21-01H Heavy duty pivot bracket (VESA 75) (max. load up to 24-28 lbs.)
		#21-14 Fold up tray pivot unit
#21-02	#21-14	#21-02 VESA 75mm to VESA 100mm adaptor plate

## Special tilt Pivot Bracket

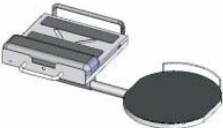
		#21-05-13 Drop Pin, 13" L (excluding #21-01 pivot head)
#21-05	#21-13	#21-13 LCD/Keyboard holder (excluding keyboard platform)

## Platforms

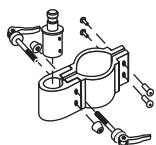

		#24-06 Clamp-Style Laptop Platform + optional mouse tray
#24-07	#24-31P	#24-07 Clamp-Style Keyboard Platform + Mouse Tray + gel wrist rest
		#24-21 Laptop platform, (15" W x 12" D)
#24-21	#24-06	#24-31P Phenolic Keyboard platform + mouse tray + gel wrist rest

## Pole clamps





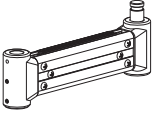
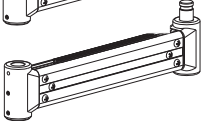
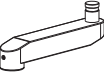



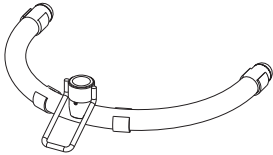

#25-40Q	Quick release 2" pole clamp
#25-42Q	Quick release 1.5" pole clamp

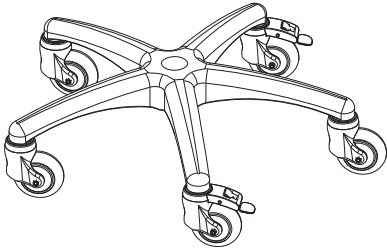
# Part information

Parts	Part Numbers	Description
<b>Extension Arms</b>		
	#22-03-1	#22-03-1 Short extension arm (10")
	#22-03-2	#22-03-2 Long extension arm (18")
	#22-06-1	#22-06-1 Die cast extension arm (6 1/2")
<b>2" Pole</b>		
	#23-22	Dia. 2" pole x 16" long
	#23-23	Dia. 2" pole x 32" long
	#23-24	Dia. 2" pole x 48" long
	#23-72	Dia. 2" pole x 72" long ( floor or ceiling mount)
16", 32" & 48" Long Poles Worksurface mount (Pole base ordered separately)	#23-26	2"/1.5" telescopic pole, height adjustment from 798mm to 1408mm
	#23-40	Pneumatic lift pole (used on 60251 mobile cart)
	#23-42	Pole base insert (used with 25-25 Round Pole base to mount 60272 Lockable arm to worksurface)
		
#23-26, Telescoping pole Ceiling mount (Pole base ordered separately)		

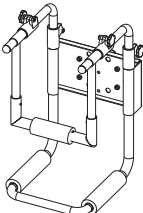
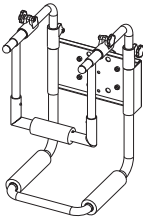
# Part information

Parts	Part Numbers	Description
<b>Pedestal mounts (for #23 series pole)</b>		
	#25-24	Die casting grommet for 23-13 telescoping pole
#25-36		#25-31-6 Free-Standing base for 23-13 telescoping pole
	#25-24	
<b>2" pole base</b>		
	#25-33	Round base for 2" pole (Screws are not included)
	#25-35	Heavy Duty round base for 2" pole (Screws are not included)
	#25-34P	Reinforced plastic mobile base (5 x 2" casters and 2 lockable)
#25-33	#25-34A	#25-34A
	#25-34A	Quality aluminum mobile base (5 x 4" wheels and 2 lockable)
	#25-35	
<b>CPU/UPS holder/Cart handle/Cable Storage</b>		
	#60606	#60606 Vertical surface mount adjustable CPU holder (wall/pole)
	P60250-10	P60250-10 Mobile cart handle (to be mounted on any single pole mount bracket)
	#60250-13	60250-13 Cable Storage Box (mounts on mobile cart pole to organize cables)

