

# Squeeze-Eze™ Power Packs and Jaws

## BEND-EZE™ Cut and Bend Tool

Air-powered cut and bend tool which cuts components on P.C. boards 1/16" above the surface and bends them over tight to the board.

The tool is small (5 1/2" long x 1 1/4" diameter) and lightweight (8oz.). Constructed of durable aluminum. Maximum inlet air pressure is 80 psi.

Seven interchangeable cut and bend heads are available for different diameter components with 20°, 30° or 45° working angles. Heads are made from hardened tool steel and are easily replaceable. There are also four heads available for shorter layover (1/32" max. layover) in 20°, 30° and 45° angles.

Special bend only models are also available. Consult factory for details. Cut and Bend Heads sold separate from power packs.

**BP-1 With Optional 4HG20 Head**



### CUT AND BEND HEADS



PRODUCT NUMBER	WIRE SIZE	WORK ANGLE
4H-20	0.010-0.028	20°
4H-30	0.010-0.028	30°
4H-45	0.010-0.028	45°
4H4-20	0.020-0.038	20°
4H4-30	0.020-0.038	30°
4H4-45	0.020-0.038	45°
4HG-20	0.030-0.050	20°

### SHORT LAYOVER CUT AND BEND HEADS

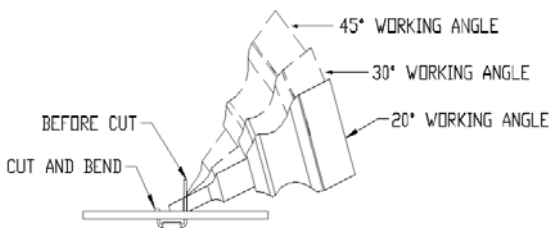

PRODUCT NUMBER	WIRE SIZE	WORK ANGLE
4H4-20-SL	0.010-0.038	20°
4H4-30-SL	0.010-0.038	30°
4H4-45-SL	0.010-0.038	45°
4HG-20-AR	0.030-0.050	20°



**Custom Products & Services, Inc.**  
 PH: 888-444-1202  
 E-Mail: [info@custom-products.com](mailto:info@custom-products.com)

# SQUEEZE-EZE™ POWER PACKS



## MSP-1 Miniature Squeeze-Eze™

This miniature power pack is for use with the cutting, crimping and bending jaws found below. The tool is small (5" long x 1 1/4" diameter) and can be operated at air pressures of 60-80 psi, producing 100 lbs. of end cutting force. A built-in adjusting screw controls the opening of the jaw sets. Jaw sets sold separate. See selection below.

MSP-1 with Optional Jaw

### SMCC-1 \ SMCC-1SR



Max. Soft Wire	0.03" (0.76 mm)
Rise	0.03" (0.76 mm)
Angle	35°
Length of Cut	0.09" (2.2 mm)
Max. Tip Opening	0.11" (2.7 mm)

### Cut and Crimp Style (SMCC and MVCC)

These jaws shear soft wire at a specified "rise" distance above the working surface and flatten the rise so it is mechanically secure before soldering. Jaws identified by the suffix "SR" do not include the crimp feature. Special order on "SR" can be furnished to cut and rise distances from 0.030 to 0.060 inch (0.076 to 1.522 mm).

### MVCC-1 \ MVCC-1SR



Max. Soft Wire	0.03" (0.76 mm)
Rise	0.03" (0.76 mm)
Angle	90°
Length of Cut	0.09" (2.2 mm)
Max. Tip Opening	0.13" (3.3 mm)

### SMCC-2 \ SMCC-2SR



Max. Soft Wire	0.03" (0.76 mm)
Rise	0.03" (0.76 mm)
Angle	35°
Length of Cut	0.25" (6.4 mm)
Max. Tip Opening	0.12" (3 mm)

### Cut and Bend Type (MCB)

When a cut and bend is preferred to a cut and crimp operation, selection of the MCB jaw will prove satisfactory. These jaws are interchangeable in the MSP-1 tool. For shear only MCB-SR with standard or selected height is available.

### MCB -SR



Max. Wire	0.03" (0.76 mm)
Cut Height	0.04" (1 mm)
Variable Height	0.03" to 0.12"

### MCB-1 \ MCB-2



Max. Wire MCB-1	0.02" (.50 mm)
Cut Height	0.04" (1.1 mm)
Layover	0.05" (1.27 mm)
Max. Wire MCB-2	0.01" to 0.30"
Cut Height	0.06" (1.5 mm)

### Dyke-Type (MCD)

All jaws are secured in the housing by a shouldered pivot screw with recessed hex head and can be reversed to facilitate right or left handed use. Jaw sets are removable for repeated re-sharpening. "CH" indicates case hardened jaw sets.

### MCD-1 \ MCD-11 \ MCD-1CH



Max. Soft Wire	0.03" (0.76 mm)
Semi-Flush Rise	0.007" (0.1 mm)
Angle	15°
Length of Cut	0.43" (10.92 mm)
Max. Tip Opening	0.15" (3.81 mm)

### MFS-1 \ MFS-1CH



<b>Filament Shears</b>
For cutting fine wire, nickel ribbon or soft wire of any metal up to 0.09" diameter (2.4 mm). Max. tip opening 0.16" (4 mm)

### MCD-2 \ MCD-21 \ MCD-2CH



Max. Soft Wire	0.30" (0.76 mm)
Semi-Flush Rise	0.007" (0.1 mm)
Angle	35°
Length of Cut	0.31" (8 mm)
Max. Tip Opening	0.15" (3.81 mm)

### MSJ-1



<b>Blank Jaws (unhardened)</b>
For use as holding pliers or can be machined and hardened to suit special requirements. Jaws are 0.25" thick (6.4 mm). Max. tip opening 0.16" (4 mm)

# SQUEEZE-EZE™ POWER PACKS



**SP-01P with Optional Jaw**

## SP-01P Squeeze-Eze™ Power Pack

This is one of our most powerful tools in the electronics group (575 lbs. force @ 80 psi), designed to be used with jaw sets listed below. The tool is small (5 1/2" long x 1 1/2" diameter) lightweight (11 oz.) and can be operated at air pressures of 60 - 100 psi. A built in adjusting screw controls the opening of the jaw sets. All power packs sold less jaws, order separate.

A foot operated model is available (SP-01PF) which includes two (2) 5 foot air hoses and hex key for use with optional A-202 bench stand. An optional four way footswitch is available (Model 105)

## SP-02P Squeeze-Eze™ Power Pack

SP-02P is designed to use the identical jaw sets as the SP-01P, but delivers considerably more power for tougher applications. Made of durable aluminum, the tool is small (5 1/2" long x 1 3/4" diameter), Lightweight (13 oz.) and can be operated at air pressures of 60-100 psi. SP-02P (850 lbs. of cutting force) can cut up to 0.10" soft steel wire.

A foot operated model, as shown, (SP-02PF) includes two (2) 5 foot air hoses and hex key for use with our optional work station or A-202 bench stand. An optional four way footswitch is available (Model #105).

## SP-02PF with Optional Jaw



### Cut and Crimp Style Jaws

These jaws shear soft wire at a specified "rise" distance above the working surface and flatten the rise so it is mechanically secure before soldering. Jaws identified by the suffix "SR" do not include the crimp feature. Special order on "SR" can be furnished to cut and rise distances from 0.03" to 0.06" (0.76 to 1.5 mm).

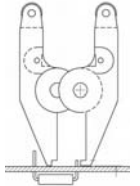

**CC-1 \ CC-1SR**



<b>Max. Soft Wire</b>	0.05" (1.27 mm)
<b>Rise</b>	0.04" (1.1 mm)
<b>Angle</b>	45°
<b>Length of Cut</b>	0.37" (9.39 mm)
<b>Max. Tip Opening</b>	0.15" (3.81 mm)

**MCC-1 \ MCC-1SR**



<b>Max. Soft Wire</b>	0.03" (0.76 mm)
<b>Rise</b>	0.03" (0.76 mm)
<b>Angle</b>	45°
<b>Length of Cut</b>	0.12" (3.04 mm)
<b>Max. Tip Opening</b>	0.20" (5.08 mm)

**MCC-2 \ MCC-2SR**



<b>Max. Soft Wire</b>	0.03" (0.76 mm)
<b>Rise</b>	0.03" (0.76 mm)
<b>Angle</b>	90°
<b>Length of Cut</b>	0.12" (3.04 mm)
<b>Max. Tip Opening</b>	0.25" (6.35 mm)

**SJ-1A**



For use as a holding pliers or can be machined to suit special requirements for cutting, crimping or holding. Jaws are 0.30" (7.62 mm) thick. Max. tip opening 0.39" (9.90 mm)

All jaws can be factory re-sharpened for longer life and reduced production costs. Special jaws may be manufactured for special operations.



**Custom Products & Services, Inc.**  
 PH: 888-444-1202  
 E-Mail: [info@custom-products.com](mailto:info@custom-products.com)

## SQUEEZE-EZE™ JAWS (cont.)

For use with SP-01P or SP-02P Power Packs

### Dyke Type Jaws

These jaws are for cutting wires flush or semi-flush. All jaws are secured in the housing by a shouldered pivot-screw with recessed hex head and can be reversed to facilitate right or left handed use. "CH" indicates case hardened jaw sets. As with all jaw sets, they may be factory re-sharpened for extended life and lower production costs.

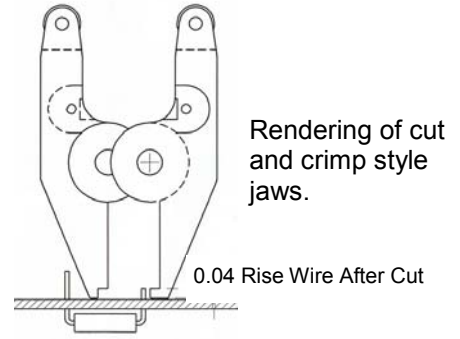

#### CD-1 \ CD-11 \ CD-1CH



<b>Max. Soft Wire</b>	0.06" (1.5 mm)
<b>Semi-Flush Cut-CD-1</b>	.007" (0.18 mm)
<b>Flush Cut-CD-11</b>	.007" (0.18 mm)
<b>Angle</b>	45°
<b>Length of Cut</b>	0.43" (11 mm)
<b>Max. Tip Opening</b>	0.20" (5 mm)

#### CD-3 \ CD-31 \ CD-3CH



<b>Max. Wire</b>	0.05" (1.2 mm)
<b>Semi-Flush Cut-CD-3</b>	.007" (0.18 mm)
<b>Flush Cut—CD-31</b>	.007" (0.18 mm)
<b>Angle</b>	15°
<b>Length of Cut</b>	0.83" (21 mm)
<b>Max. Tip Opening</b>	0.30" (7.63 mm)

#### CD-4CH



<b>Max. Soft Wire</b>	0.08" (2 mm)
<b>Semi-Flush Cut</b>	Center Cut
<b>Angle</b>	N/A
<b>Length of Cut</b>	0.50" (12.7 mm)
<b>Max. Tip Opening</b>	0.19" (4.8 mm)

#### CD-5CH



<b>Plastic or Wire</b>	0.05" (1.2 mm)
<b>Semi-Flush Cut</b>	Tapered to Edge
<b>Angle</b>	15°
<b>Length of Cut</b>	0.83" (21 mm)
<b>Max. Tip Opening</b>	0.30" (7.63 mm)

#### HCC-1



<b>Max. Soft Wire</b>	0.06" (1.52 mm)
<b>Rise</b>	0.04" (1.02 mm)
<b>Angle</b>	45°
<b>Length of Cut</b>	0.19" (4.8 mm)
<b>Max. Tip Opening</b>	0.10" (2 mm)

#### HMCC-1



<b>Soft Copper Wire</b>	.031" (7.8 mm)
<b>Rise</b>	.041" (1.04 mm)
<b>Angle</b>	45°
<b>Length of Cut</b>	0.13" (3.3 mm)
<b>Max. Tip Opening</b>	0.20" (5 mm)

#### FS-1/FS1CH/Carbide



Filament shears for cutting fine wire, nickel ribbon or soft wire of any metal up to 0.13" diameter (3.3 mm). Jaws are 0.75" (19 mm) long. Maximum tip opening 0.21" (5.3 mm)

#### PC-311F



<b>PC Tab Cutter</b>	0.05" (1.27 mm)
<b>Flush Cut</b>	
<b>Angle</b>	25°
<b>Length of Cut</b>	0.45" (11.45 mm)
<b>Max. Tip Opening</b>	0.26" (6.60 mm)

Most jaws are available with carbide inserts. Please consult factory for pricing and availability.

CPS has a full team of engineers to help with special needs. Custom designed tools and jaws are an integral part of CPS business.













CPS web site: [www.custom-products.com](http://www.custom-products.com) TOLL-FREE PH: 888-444-1202

# CRIMPING TOOLS

## UC-90 Universal Crimp Tool

Our universal crimp tool is a complete system, including an SP-004F power pack, universal crimp jaw and housing (die sets separate), bench stand and footswitch. Thirteen interchangeable crimping die sets (shown below) are available for processing connectors in applications such as COAX, stranded wire, HEX-style and open/closed barrel. The UC-90 can accommodate optional power packs up to our SP-008F for added crimping pressures. An optional locator shelf is available (#UC-L) to assist in uniform crimping.



	<p align="center"><b>UC50-1</b></p> <p>RG58, RG59/62, AU, BNC/TNC, 3-pc. hex cavities for MS39012-type, AMP, Trompeter, Kings, Amphenol and other connector. Triple hex cavity die with crimp dimensions of .255, .213 and .068</p>		<p align="center"><b>UC50-7</b></p> <p>RG59 and RG6, CATV "F" connectors. Triple hex die with crimp dimensions of .350, .320 and .255</p>
	<p align="center"><b>UC50-2</b></p> <p>RG59, RG8281 and RG6 cable groups and 50-75 OHM cables. Quad hex die with crimp dimensions of .324, .255, .068 and .042.</p>		<p align="center"><b>UC50-8</b></p> <p>22-10 AWG red, yellow and blue fully insulated quick disconnect terminals. Triple cavities with crimp dimensions to .355, .255 and .235</p>
	<p align="center"><b>UC50-3</b></p> <p>RG58, RG174 and RG-8128 cable groups for 50-75 OHM cables. Quad hex die with crimp dimensions of .213, .178, .068 and .042.</p>		<p align="center"><b>UC50-9</b></p> <p>22-10 AWG red, yellow and blue fully insulated quick-disconnect terminals. Triple cavities with crimp dimensions of .340, .255 and .245</p>
	<p align="center"><b>UC50-4</b></p> <p>RG8/11 Ethernet Thickwire, N-series MS39012-type plugs and jacks for RG213 and RG216 cables. Triple hex cavity die with crimp dimensions of .429, .100 and .080</p>		<p align="center"><b>UC50-10</b></p> <p>22-12 AWG open barrel ("F" Mate-N-Lock) connectors. Triple cavities with crimp dimensions of .165, .100 and .090.</p>
	<p align="center"><b>UC50-5</b></p> <p>RG58 and RG59 Plenum and Teflon cables. Quad hex die with crimp dimensions of .190, .213, .068 and .042</p>		<p align="center"><b>UC50-11</b></p> <p>26-16 AWG red, yellow and blue miniature insulated rings, spades and butt splices. Triple cavity with crimp dimensions of .148, .234 and .240</p>
	<p align="center"><b>UC50-6</b></p> <p>22-8 AWG non insulated ring, spade and butt splice terminals. Quad cavity die with crimp dimensions of .295, .225, .160 and .140</p>		<p align="center"><b>UC50-12</b></p> <p>Universal RJ-11 modular telecommunication plug for 2, 4 or 6 position plugs</p>
			<p align="center"><b>UC50-13</b></p> <p>Universal RJ-45 eight-position die set for keyed or non-keyed modular plugs (excluding AMP).</p>

[www.custom-products.com](http://www.custom-products.com)

TOLL FREE PH: 888-444-1202

# CRIMPING TOOLS



**CM-3  
Jaw and Housing**

## Crimp-Master™

The CM-3 Crimp-Master™ (Shown with optional CM3-2 insert) secures solderless terminals to solid or stranded, bare or insulated wire, to meet most requirements of several MIL specifications. It fits on to our SP-002 to SP-005 Power Packs (based on power required for crimp), and features a durable aluminum housing with hardened tool steel jaws. Most crimping performed with “F” style power packs (consult CPS). Optional inserts can handle from #22 to #8 AWG wire.



**SP-004  
Power Pack (Ordered separate)**

Power Pack	SP-002	SP-003	SP-004	SP-005
Force—lbs.	1800	2000	2400	3500
Force—kgs	815	910	1090	1590

Inlet air pressure of 80 psi will develop approximately the crimping forces shown using the corresponding power pack.

### CM3-1 Insert



#### Crimping Specifications

Wire Gauge	14 to 22
Terminal Bare Wire	YES
Insulated Wire	NA

### CM3-2 Insert



#### Crimping Specifications

Wire Gauge	12 to 16
Terminal Bare Wire	N/A
Insulated Wire	Red & Blue Identifier

### CM3-3 Insert



#### Crimping Specifications

Wire Gauge	8 to 16
Terminal Bare Wire	N/A
Insulated Wire	Yellow Identifier

### CM3-4 Insert



#### Crimping Specifications

Wire Gauge	Wire Cap
Terminal Bare Wire	N/A
Insulated Wire	14 to 22

## HandWorker®

Turn your **Hand** tools in to **Pneumatic** hand tools. The control is all yours. Cut, Crimp, Hold, Strip, Nick, Punch, Rivet and more.

Holds an amazing range of tools, from instrument size pliers to large and unusual tools.

Just another way to help relieve hand strain and to reduce “Repetitive Motion Disorders”.



# COMPONENT LEAD PROCESSORS



## CLP-274 Component Lead Processor

The Model 274 is a semi-automatic lead processing tool. The CLP-274 features optional interchangeable dies (shown below) and can process up to 1200 pieces an hour. The tool operates at 40-60 psi using the included foot switch. Component lead processor dies are available in two styles: Trimming and Forming. The forming dies feature our lock-in capability, allowing the component to be spaced-off the P.C. board and locked-in, eliminating the need for swagging or trace-pads. Trimming dies simply cut off to various lengths.

Power pack is made of aluminum. Unit is 3" high x 5 3/4" long x 3 1/2" wide and weighs 1 pound. Die sets are oil-hardened tool steel 1" wide x 2" long.

Blank Die Set				
CLP-000	Unhardened Blank Die Set / 1 each 1/32", 1/16", 3/32"		Total Die Thickness .257"	
Lead Processor Transistor Dies				
CLP-020	Universal Transistor Trimming		.100 (2.54) Bolt Circle .200 (5.08) Bolt Circle .300 (7.62) Bolt Circle	.200"  .035"
CLP-021	Trim, Stand-Off and Lock-In Die T0 5 (2.36) 3/32" above board (1.57) 1/16" board (1.98) 5/64" below board		.200 (5.08) Bolt Circle	.235"  .040"
CLP-022	T0 3 to T0 5 Spread, Trim and Lock-In Die (3.96) 3/32" above board (1.57) 1/16" board (1.98) 5/64" below board		.200 (5.08) Bolt Circle	.325"  .040"
CLP-024	T0 3 to T0 5 Spread and Trim Die Length increments of 1/32" (.81) (9.52) 3/8" max. length		.100 (2.54) Bolt Circle .200 (5.08) Bolt Circle	.225"  .040"
Lead Processor Transistor Dies				
CLP-040	Universal Capacitor Trimming Die with hole spacing in increments of .050 (1.27) from .100 (2.54) to .900 (22.86)		Any center less than 1.00 (25.4) and any length in increments of 1/32" to 3/8"	.200"  .035"
CLP-041	Capacitor Trim and Lock-In Die Also for resistor cut and lock-in		.025 (.66) lead diameters: 1/4"-3/8"-1/2"-5/8"-3/4" (6.35-9.52-12.7-15.87-19.05) Centers	.235"  .043"
CLP-042	Trimming of Any In-Line Leads — power transistors, S.C.R.'s and TRIAC's		Any center less than .900 (22.86)	.225"  Slot Width .060"
Lead Processor I.C. Dies				
CLP-060	8 Lead I.C. Square Trimming Die		.200 (5.08) Square	.225"  Hole Dia .035"
CLP-061	8 Lead I.C. Round Trimming Die Height in 1/32" (.81) increments; Max. 3/8" (9.52)		.200 (5.08) Bolt Circle	.200"  .035"
CLP-062	16 Lead Dual In-Line Trimming Die* *For Uncut Opposite Corner Leads, Specify Special Blade		.100 (2.54) Centers	.093"  .035"
CLP-064	8 Lead I.C. Spreading Die Height in 1/32" (.81) increments; Max. 3/8" (9.52) Changes bolt circle from .200 to .300		.300 (7.62) Bolt Circle	.225"  .035"
CLP-065	10 Lead I.C. Trimming Die		.300 (7.62) Bolt Circle	.225"  .035"

# COMPONENT LEAD PROCESSOR







## CLP2000 Component Lead Processor

The CLP-2000 is a larger, more powerful version of our CLP-274. Featuring our SP-002 power pack, which delivers 176 lbs. of thrust, the CLP-2000 has a full 1 1/2" stroke. Designed for semi-automatic parts processing, the unit can trim up to 1000 pieces per hour. Recommended air pressure is 60-80 psi. The unit is operated off of a foot switch, which is supplied.

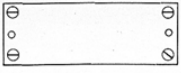
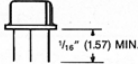
The CLP-2000 features interchangeable steel die sets (sold separately). Dies are oil hardened tool steel 1 3/4" wide x 5 1/4" long. Standard trimming dies are shown below. Special made die sets and larger units (up to 7" width) are available upon request. Contact CPS engineering department for quote.

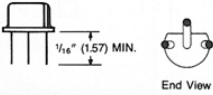
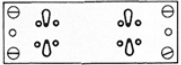
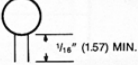
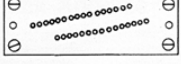
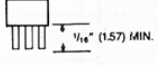
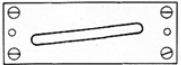
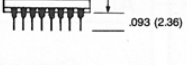
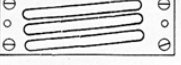
Unit dimensions are 3" high x 8" long x 5 1/4" wide and weighs 4 1/2 lbs.

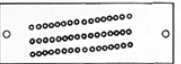
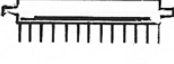
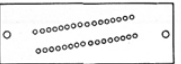
Blank Die Set				
<b>CLP-2001</b>	Unhardened Blank Die Set / 1 each 1/16", 3/32", 1/8"			Total Die Thickness .280" 
Lead Processor Transistor Dies				
<b>CLP-2002</b>	Universal Transistor Trimming		.100 ( 2.54) Bolt Circle .200 ( 5.08) Bolt Circle .300 ( 7.62) Bolt Circle .400 (10.00) Bolt Circle	.093"  Hole Dia. .046"
<b>CLP-2003</b>	Spread and Trim Die Length increments of 1/16" (1.57) to a maximum of 3/8" (9.52) length.		.100 ( 2.54) Bolt Circle .200 ( 5.08) Bolt Circle .300 ( 7.62) Bolt Circle	.250"  Hole Dia. .046"
Lead Processor Capacitor Dies				
<b>CLP-2004</b>	Universal Capacitor Trimming Die with hole spacing in increments of .050 (1.27)		Hole diamter .0035" Any center less than 4.00" (100.00) and any lead diameter less than .045" (1.13)	.093"  Hole Dia. .046"
<b>CLP-2005</b>	Trimming of any in-line lead: diodes, TRIAC's, S.C.R.'s, etc.		Any center less than 4.00" (100.00) slot width .062" (1.55)	.186"  Slot Width .062"
Lead Processor I.C. Dies				
<b>CLP-2006</b>	Dual In-Line Trimming Die		.100 ( 2.54) Centers .300 ( 7.62) Centers .600 (15.00) Centers 4.00" Slot Length	.186"  Slot Width .062"
Lead Processor Connector Dies				
<b>CLP-2007</b>	Universal Trimming of any Connector up to 4.00" (100.00)		.100 (2.54) Centers .200 (5.08) Centers .300 (7.62) Centers .050 Pin Spacing	.093"  Hole Dia. .046"
<b>CLP-2008</b>	Specialty Connector Trimming Die for any Odd Style Connector		As requested up to 4.00" (100.00) length	.093"  Any Spec.

# ERGONOMIC WORK STATIONS AND HOLDERS

This line of ergonomic support systems is for use with any power pack or jaw set combination. Helping to relieve the strain and fatigue of hefting a power pack all day, these systems will help improve productivity while eliminating injuries through ergonomic design. The optional tool balancer and tool harness is made for holding the power pack and jaw set in a horizontal position



## WS-2000 ERGONOMIC WORK STATION

The WS-2000 Ergonomic work station is a sturdy support system for use with any of the power packs in our product line. This heavy duty work station features a 36" horizontal, 180° boom, attached to a 48" vertical column with a base that mounts easily to bench tops. The boom can be adjusted vertically higher or lower on the column to suit your specific application. Also included with the WS-2000 is a balancer trolley that can support either a TB-1 or TB-2 tool balancer (tool balancer optional). This heavy-duty trolley is of ball bearing construction and can support up to 30 pounds, allowing more free space in the work place.

The **WS-2000 and A-202 Series** of work stations and bench stands are designed to be mounted on tables or work stations by either bolting through holes provided or by using CPS part number BC-1 bench clamp.

The A-202 series of bench stands allows the tool to be rotated easily to position the tool for optimum cutting. The bench stand is further designed to be easily integrated onto robotic arms or moving work stations.

## TOOL BALANCER AND TOOL HARNESS



Tool Balancer

TB-1	TB-2
13 oz.	5 lbs.

Supports to weight shown

Tool Harness

TH-1	TH-2
Use w/SP-01P-SP-02P	Use w/SP-002—SP-008

## A-202 SERIES BENCH STAND

ITEM NUMBER	USE WITH POWER PACK #
A-202-1	SP-01F and SP-001F
A-202-2	SP-02F and SP-002F
A-202-3	SP-003F
A-202-4	SP-004F



# ACCESSORIES



103

## FOOT SWITCHES

For use with all power packs with "F" suffix.  
(i.e. SP-002F)



105



101-, 102- Series

## AIR HOSES

5,7,10,15 Foot wtwo 1/8" npt fittings

5,7,10,15 Foot wone 1/8" npt and one 1/4" npt fitting

10 Foot coil hose wone 1/8" npt and one 1/4" npt fitting



102-10C

VISIT OUR WEBSITE AT:

[www.custom-products.com](http://www.custom-products.com)