



Custom Products & Services, Inc.

6140 Claude Way E.

Inver Grove Heights, MN. 55076

PH: 888-444-1202 (Toll Free) or 651-452-0113 FAX: 651-452-2264

E-MAIL: info@custom-products.com

WEBSITE: www.custom-products.com



"Your source for workplace solutions"

ORDER GUIDE

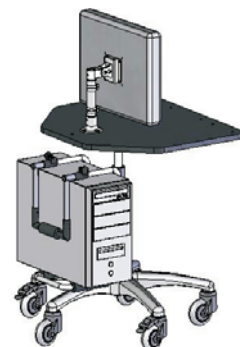



MOUNTS FOR LCD DISPLAYS, KEYBOARDS, LAPTOPS, CPU's

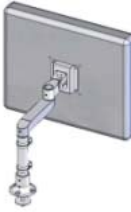

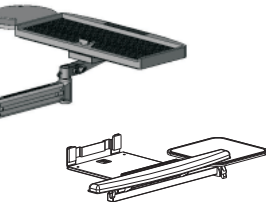

Configurations

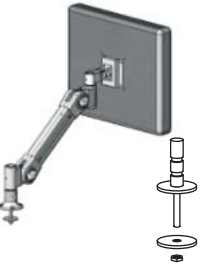
Configurations	Part Selections	Part Numbers	Descriptions
#60210 series Worksurface mount LCD arm 	1. Pivot Head	#21-01	VESA 75mm pivot bracket
		#21-01H	Heavy duty pivot bracket (VESA 75)
		#21-21Q	Track mount quick release pivot adapter
	2. Adjustable arm	#22-04-3	Adjustable Arm, (15" L) Wt. capacity: 5.5 lbs - 15 lbs.
#22-04-5		Adjustable Arm, (15"L) Wt. capacity: 16 lbs - 28 lbs.	
3. Extension arm	#22-06-1	Die cast extension arm (6 ½" L)	
	#22-07-1	Dual LCD mount extended bar	
4. Mount	#25-01	C-Clamp	
	#25-22	Grommet Pin	
#60212 series Vertical surface mount LCD arm 	1. Pivot Head	#21-01	VESA 75mm pivot bracket
		#21-01H	Heavy duty pivot bracket (VESA 75)
		#21-21Q	Track mount quick release pivot adapter
	2. Adjustable arm	#22-04-3	Adjustable Arm, (15" L) Wt. capacity: 5.5 lbs - 15 lbs.
#22-04-5		Adjustable Arm, (15"L) Wt. capacity: 16 lbs - 28 lbs.	
3. Extension arm	#22-06-1	Die cast extension arm, (6 ½" L)	
	#22-07-1	Dual LCD mount, extended bar	
4. Mount	#25-12	Wall mount bracket	
	#25-40Q	2" pole clamp (single mount)	
	#25-42Q	1- 1/2" pole clamp (single mount)	
#60216 Compact LCD arm 	1. Pivot Head	#21-01	VESA 75mm pivot bracket
		#21-01H	Heavy duty pivot bracket (VESA 75)
#21-21Q		Track mount quick release pivot adapter	
2. Mount	#25-12	Wall mount bracket	
	#25-40Q	2" pole clamp (single mount)	
	#25-42Q	1 1/2" pole clamp (single mount)	
#60217 Series LCD Pedestal 	1. Pivot Head	#21-01	VESA 75mm pivot bracket
		#21-01H	Heavy duty pivot bracket (VESA 75)
		#21-21Q	Track mount quick release pivot adapter
	2. Telescopic pole	#23-13	Telescopic pole, height adjustment from 12 3/8" to 16 3/8"
3. Extension arm	#22-06-1	Die cast extension arm (6 ½" L)	
4. Mount	#25-02	C-clamp for telescopic pole	
	#25-24	Die casting grommet for telescopic pole	

Configurations

Configurations	Part Selections	Part Numbers	Descriptions
#60218 Series Extended Holder   	1. Tray	#24-07 #24-21 #24-31P	New Keyboard Clamp (w/optional mouse tray) Laptop platform (15"x12") Phenolic Keyboard Platform + mouse tray + Vinyl wrist rest
	2. Pivot Head	#21-14	Fold up tray pivot unit
	3. Extension Arm	#22-03-1 #22-03-2 #22-06-1	Short extension arm (10") Long extension arm (18") Die cast extension arm (6 1/2") *
	4. Mount	#25-12 #25-40Q #25-42Q	Wall mount bracket 2" pole clamp (single mount) 1 1/2" pole clamp (single mount)
#60220 series Desk top mount LCD arm  	1. Pivot Head	#21-01 #21-01H #21-21Q	VESA 75mm pivot bracket Heavy duty pivot bracket (VESA 75) Track mount quick release pivot adapter
	2. Adjustable arm	#22-04-3 #22-04-5	Adjustable Arm, 15" L, Wt. capacity: 5.5-15 lbs. Adjustable Arm, 15" L, Wt. capacity: 16-28 lbs
	3. Extension arm	#22-06-1	Die casting swing arm 165mm(6 1/2")
	4. Mount	#25-22	Grommet Pin
#60221 series Vertical surface mount swing arm 	1. Pivot Head	#21-01 #21-01H #21-21Q	VESA 75mm pivot bracket Heavy duty pivot bracket (VESA 75) Track mount quick release pivot adapter
	2. Extended Arm	#22-03-1 #22-03-2	Short extension arm (10") Long extension arm (18")
	3. Mount	#25-12 #25-42 #25-40	Wall mount bracket 1.5" pole mount bracket 2" pole mount bracket

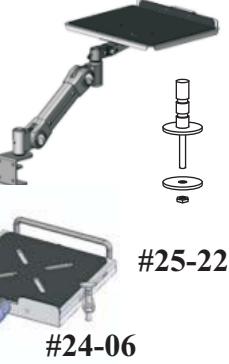
Configurations

Configurations	Part Selections	Part Numbers	Descriptions
#60222 series Vertical surface mount 2-arm system 	1. Pivot Head	#21-01 #21-01H #21-21Q	VESA 75mm pivot bracket Heavy duty pivot bracket (VESA 75) Track mount quick release pivot adapter
	2. Extended Arm	#22-03-1 #22-03-2	Short extension arm (10") Long extension arm (18")
	3. Adjustable Arm	#22-04-3 #22-04-5	Adjustable Arm, 15" L, Wt. capacity: 5.5-15 lbs. Adjustable Arm, 15" L, Wt. capacity: 16-28 lbs.
	4. Mount	#25-12 #25-40Q #25-42Q	Wall mount bracket 2" pole clamp (single mount) 1 1/2" pole clamp (single mount)
#60223 series Adjustable Platform 	1. Tray	#24-21 #24-06	Laptop platform (15" W x 12" D) Adjustable Clamp-Style Laptop Platform
	2. Pivot Head	#21-14	Fold up tray pivot bracket
	3. Adjustable Arm	#22-04-3	Adjustable Arm, 15" L, Wt. capacity: 5.5-15 lbs.
	4. Extension arm	#22-06-1	Die cast swing arm, (6 1/2" L)
	5. Mount	#25-01 #25-12 #25-22	2 in 1 mount (C-Clamp) Wall mount bracket Grommet Pin
#60225 Series Wall mount Dual swing arm 	1. Pivot Head	#21-01 #21-01H #21-21Q	VESA 75mm pivot head Heavy duty pivot head(VESA 75) VESA 75 quick release pivot head
	2. 1st extension arm	#22-03-1 #22-03-2 #22-06-1	Short extension arm (10") Long extension arm 450mm(18") Die casting swing arm (6-1/2")
	3. 2nd extension arm	#22-03-1 #22-03-2 #22-06-1	Short extension arm(10") Long extension (18") Die casting swing arm (6 1/2")
	4. Mount	#25-12 #25-40-Q #25-42-Q	Two ear wall mount bracket 2" Pole Clamp, Single 1.5" Pole Clamp, Single

Configurations

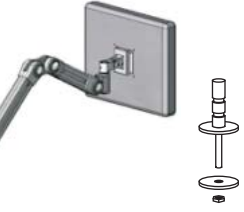

Configurations	Part Selections	Part Numbers	Descriptions
#60226 series Desk top mount Foldable arm	1. Pivot Head	#21-01	VESA 75mm pivot bracket
		#21-01H	Heavy duty pivot bracket (VESA 75)
		#21-21Q	Track mount quick release pivot adapter
	2. Foldable Arm	#26-31-52	Dual Adjustable Arm reach, 39" L, Wt. capacity: 4-11 lbs.
	3. Mount	#25-22	Grommet Pin
#25-22			

#60217 Series LCD Free stand	1. Pivot Head	#21-01	VESA 75mm pivot bracket
		#21-01H	Heavy duty pivot bracket (VESA 75)
		#21-21Q	Track mount quick release pivot adapter
	2. Telescopic pole	#23-13	Telescopic pole, height adjustment from (12 3/8") to (16 3/8")
	3. Base	#25-36	U-Base (Free-standing) for 23-13 telescoping pole



Sold as complete assembly			
#60240C Series LCD Ceiling mount (May also be mounted to horizontal surface)	1. Tilt Pivot Head	VESA 75mm x 75mm	
	2. Swivel Base	Lockable steel round base	
			

#60240F Series FlexiStand	1. Pivot Head	VESA 75mm x 75mm	
	2. Swivel Base	Heavy free base	
			



Configurations

Configurations	Part Selections	Part Numbers	Descriptions
#60226 series Wall or pole mount Foldable arm 	1. Pivot Head	#21-01 #21-01H #21-21Q	VESA 75mm pivot bracket Heavy duty pivot bracket (VESA 75) Track mount quick release pivot adapter
	2. Foldable Arm	#26-31-52	Dual Adjustable Arm, 39-3/8" L Wt. capacity 2 - 11 lbs.
	3. Mount	#25-12 #25-40Q #25-42Q	Wall mount bracket 2" pole clamp (single mount) 1 1/2" pole clamp (single mount)
#60239 Series Adjustable LCD & KB holder  #24-07 (shown with P-24-12-10 mouse Tray)	1. Pivot Head	#21-01 #21-01H #21-21Q	VESA 75mm pivot bracket Heavy duty pivot bracket (VESA 75) Track mount quick release pivot adapter
	2. Tray	#24-31P #24-07	Phenolic keyboard platform (Standard) (Includes mouse tray & vinyl wrist rest) Adjustable Clamp-Style Keyboard Platform (Optional) (Mouse tray #P-24-12-10 ordered separately)
	3. Tilt Pivot Head	#21-13	Universal LCD/KB support pivot bracket
	4. Adjustable arm	#22-04-5	Adjustable Arm, 15" L. Wt. cap: 15-28 lbs.
	5. Mount	#25-12 #25-40Q #25-42Q	Wall mount bracket 2" pole clamp (single mount) 1 1/2" pole clamp (single mount)

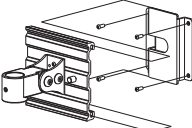
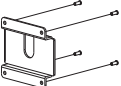
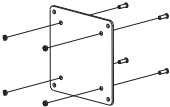
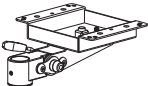

Part information

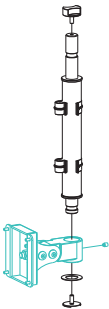
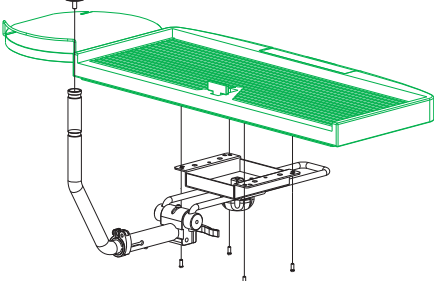
Parts	Part Numbers	Description
Pivot Brackets & Adaptor plates		
	#21-01	VESA 75 pivot bracket (max. load up to 24 lbs)
	#21-01H	Heavy duty pivot bracket (VESA 75) (For 24-28 lb. loads)
	#21-21Q (Available 6-2008)	VESA 75 track mount sliding adaptor
	#21-21	VESA 75 track mount quick release pivot bracket
	#21-02	VESA 75mm to VESA 100 mm adaptor plate
	#21-14	Fold up tray pivot unit

Tilt Pivot Bracket

	#21-05	#21-05-13 Vertical Drop Pin, 13" L (#21-01 Pivot Bracket ordered separately)
	#21-13	#21-13 LCD/Keyboard holder (keyboard platform ordered separately)
	#24-07	#24-07 Optional Clamp-Style Keyboard Platform (Mouse Tray #24-12-10 ordered separately)

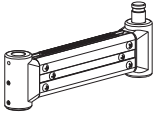
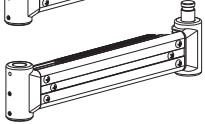
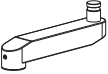
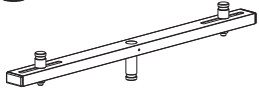
Part information

Parts	Part Numbers	Description
Extension Arms		
	#22-03-1	#22-03-1 Short extension arm (10")
	#22-03-2	#22-03-2 Long extension arm (18")
	#22-06-1	#22-06-1 Die cast extension arm (6 1/2")
	#22-07-2	#22-07-2 Dual LCD mount extended bar
	P22-07-04	P22-07-04 #22-07-2 extended bar add-on center pivot set

Telescopic pole



#23-13

#23-13 Spring assisted telescopic pole with cable clips, height adjustment from 12 3/8"-16 3/8"

2" Pole



16", 32" & 48" Long Poles
Worksurface mount
(Pole base ordered separately)

#23-22 Dia. 2" pole x 16" long (worksurface mount)

#23-23 Dia. 2" pole x 32" long (worksurface mount)

#23-24 Dia. 2" pole x 48" long (worksurface mount)

#23-26 2"/1.5" telescopic pole, height adjustment from 31-1/2" - 55"
(ceiling mount)

#23-40 Pneumatic lift pole
(used on 60251 series mobile carts)



#23-26, Telescoping pole
Ceiling mount
(Pole base ordered separately)

#23-42 2" pole insert
(used with 25-33 or 25-35 round base to mount 60272 lockable arm to worksurface)

Part information

Parts	Part Numbers	Description
-------	--------------	-------------

Adjustable Arms

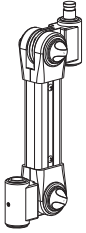

#22-04 series

- #22-04-3 Adjustable Arm, 15" L
(weight capacity: 5.5-15 lbs)
- #22-04-5 Adjustable Arm, 15" L
(weight capacity: 16 - 28 lbs.)



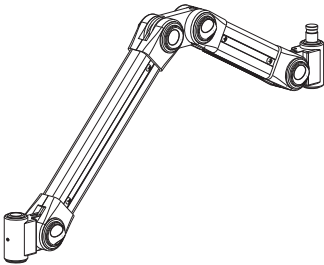

Foldable arm





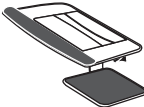

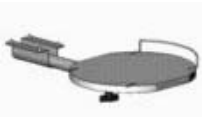
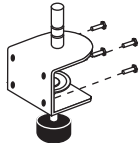
#26-31-52

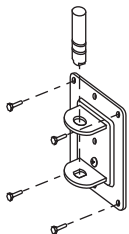
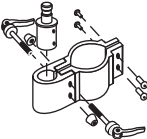
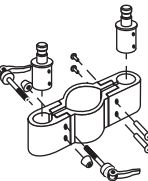
- #26-31-52 Dual adjustable Arm, 39-3/8" L
Wt. Capacity: 2-11 lbs.

Part information

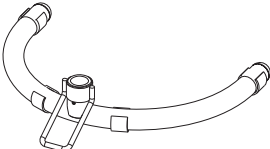
Parts	Part Numbers	Description
Holding platforms		
	#24-21	Laptop platform, 15" W x 12" D
#24-31P	#24-31P	Phenolic Keyboard platform (Includes vinyl wrist rest & Mouse tray)
	#24-21	#24-06 Adjustable Clamp Style Laptop Platform
	#24-06	#P24-12-10 (Optional mouse tray for #24-06 Laptop Platform)
#P24-12-10		
C-clamp mount		
	#25-01	2 in 1 mount C-Clamp
#25-01		
Desk top mounts		
	#25-22	Steel grommet mount
#25-22		
Vertical surface mounts		
	#25-12	Wall mount bracket
#25-12		
	#25-40Q	#25-40-Q Quick release 2" Single pole clamp
#25-42Q	#25-41Q Quick release 2" dual pole clamp	#25-42Q Quick release 1.5" Single pole clamp
	#25-41Q	#25-43Q Quick release 1.5" dual pole clamp
#25-43Q		

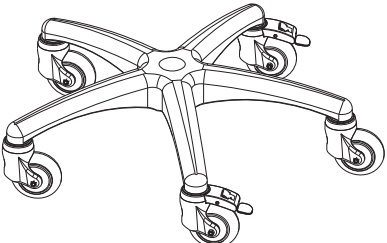
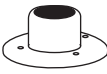
Part information

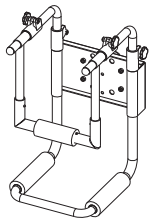
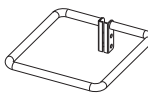
Parts	Part Numbers	Description
Pedestal mounts (for #23-13 pole)		
		#25-24 Die casting grommet for #23-13 telescoping pole
#25-36	#25-24	#25-36 U-Base (Free-Standing) for #23-13 telescoping pole
2" pole base		
	#25-33 Round base for 2" pole (Screws are not included)	
#25-34A	#25-35 Heavy Duty round base for 2" pole (Screws are not included)	
	#25-34P Reinforced plastic mobile base (5 x 2" plastic casters and 2 lockable)	
#25-33	#25-34A Quality aluminium mobile base (5 x 4" Medical casters. 2 lockable)	
		
#25-35		
CPU/UPS holder/Cart handle		
		#60606 Vertical surface mount adjustable CPU holder (wall/pole)
#60606	P60250-10	P60250-10 Mobile cart handle (to be mounted on any single pole mount)

Part information

Mobile Carts

Parts

Part Numbers

Description



#60250 Mobile Plastic Base w/ 48" L Pole

Optional items (shown) include:

- #21-01 LCD Pivot Bracket
- #21-02 Adaptor Plate (100mm VESA)
- #25-40 Single Pole Bracket for 2" pole
- #22-06-1 Extension Arm, 6-1/2" L
- #60606 CPU Holder
- #60250-10 Pull Handle

Optional items available (not shown):

- #60250-13 Cable Management Box
- #24-21 Laptop Platform (12" x 15")
- #24-06 Clamp-style laptop Platform



#60251 Mobile Aluminum Base w/ 48" L Pole
MDF Worksurface,
Telescoping lift cylinder.

Optional items (shown) include:

- #60217 LCD Mount w/ adjustable post
- #21-02 Adaptor plate, 100mm VESA
- #60606 CPU Holder
- #60250-13 Cable Management Box