



Custom Products & Services, Inc.

6140 Claude Way E.

Inver Grove Heights, MN. 55076

PH: 888-444-1202 (Toll Free) or 651-452-0113 FAX: 651-452-2264

E-MAIL: info@custom-products.com

WEBSITE: www.custom-products.com

"Your source for workplace solutions"

ORDER GUIDE

POLE MOUNTS

**FOR LCD DISPLAYS, KEYBOARDS,
LAPTOPS, CPU's**

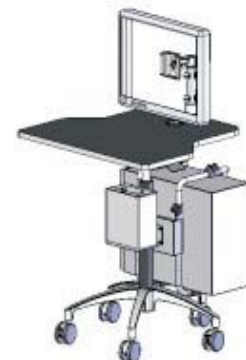
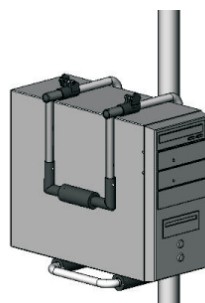

Configurations

POLE MOUNT SERIES



#60250 mobile cart



Pole mount LCD/KB holder



Pole mount LCD/KB holder

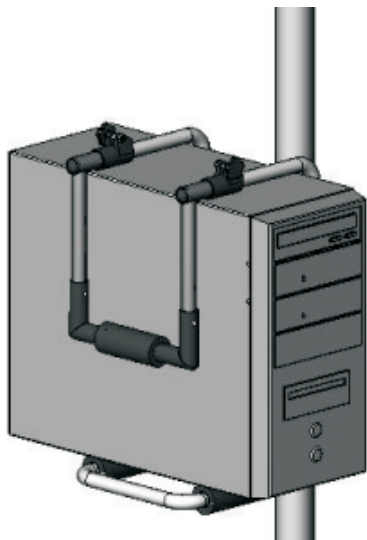







Pole mount CPU holder







#60251 mobile cart

Configurations

Configurations	Part Selections	Part Numbers	Descriptions
	1a. Pivot head	#21-01	VESA 75 pivot bracket
		#21-01H	Heavy duty pivot bracket (VESA 75)
	1b. Options	#21-13	LCD/Keyboard holder (excluding keyboard tray)
		#21-14	Fold up tray pivot unit
Standard Keyboard (left) Clamp-Style Keyboard (Right)	2. Pole	#23-22	Dia. 2" pole x 16" long
		#23-23	Dia. 2" pole x 32" long
		#23-24	Dia. 2" pole x 48" long
		#23-72	Dia. 2" pole x 72" long
		#23-26	2"/1.5" telescopic pole (33-1/2" - 55", Ceiling Mount)
		Adjustable LCD	3. Pole clamp
#25-41Q	Quick release 2" dual mount pole clamp (back-to-back)		
	4. Mounting base (See Page 7)	#25-42Q	Quick release 1.5" single mount pole clamp
		#25-43Q	Quick release 1.5" dual mount pole clamp (back-to-back)
Standard Laptop Platform (left) Clamp-Style Laptop Platform (right)	5. Platforms	#25-24	Die cast grommet for 1.5" telescoping pole
		#25-33	Round base for 2" pole (Excluding screws)
		#25-35	Heavy Duty round base for 2" pole (Screws are not included)
Foldable arm LCD mount	5. Platforms	#24-06	Clamp-Style Laptop Platform (#P-24-12-10 Optional mouse tray available)
		#24-07	Clamp-Style Keyboard Platform (Includes Mouse Tray & gel wrist rest)
		#24-21	Laptop platform, (15" W x 12" D)
	6. Swing arm	#24-31P	Phenolic Keyboard platform + mouse tray + gel wrist rest
		#22-06-1	Die cast Extension arm (6 1/2" L)
Adjustable extended LCD mount	7. Adjustable arm	#22-04-3	Adjustable arm, 15" L. Wt. capacity: 5.5-15 lbs.
		#22-04-5	Adjustable arm, 15" L. Wt. capacity: 16-28 lbs.
		#26-31-52	Arm reach, 39 3/8" L. Wt. capacity: 2-11 lbs.

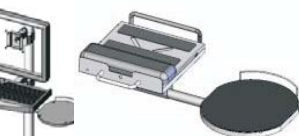
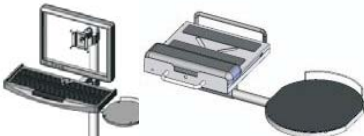

Configurations

Configurations	Part Selections	Part Numbers	Descriptions
Pole mount extension arm series 	1a. Pivot head	#21-01	VESA 75 pivot bracket
		#21-01H	Heavy duty pivot bracket, (VESA 75)
Extended LCD 	1b. Options	#21-13	LCD/Keyboard holder (excluding keyboard tray)
		#21-14	Fold up tray pivot unit
Dual arm LCD mount 	2. Pole	#23-22	Dia. 2" pole 16" long
		#23-23	Dia. 2" pole x 32" long
		#23-24	Dia. 2" pole x 48" long
		#23-25	Dia. 2" pole x 72" long
		#23-26	2"/1.5" telescopic pole, (33.5-55" L, Ceiling Mount)
		#23-26	2"/1.5" telescopic pole, (33.5-55" L, Ceiling Mount)
Standard Keyboard (left) Keyboard Clamp (right) Mouse Tray shown above 	3. Pole clamp	#25-40Q	Quick release 2" single mount pole clamp
		#25-41Q	Quick release 2" dual mount pole clamp (back-to-back)
		#25-42Q	Quick release 1.5" single mount pole clamp
		#25-43Q	Quick release 1.5" dual mount pole clamp (back-to-back)
Extended dual swing arm 	4. Mounting base	#25-24	Die casting grommet for 23-13 telescoping pole
		#25-33	Round base for 2" pole (Excluding screws)
		#25-35	Heavy Duty round base for 2" pole (Screws are not included)
Extended dual swing arm 	5. Platform	#24-06	Clamp-Style Laptop Platform (#P-24-12-10 optional mouse tray available)
		#24-07-M	Clamp-Style Keyboard Platform (includes mouse tray & gel wrist rest)
		#24-21	Laptop platform, (15" W x 12" D)
		#24-31P	Phenolic Keyboard platform + mouse tray + gel wrist rest
		P-24-12-10	Mouse Tray for use with #24-06 & #24-07-M

Part information

Parts	Part Numbers	Description
-------	--------------	-------------



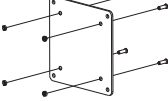
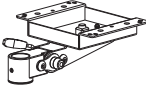

Tilt Pivot Head

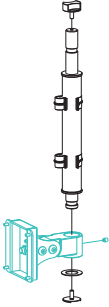
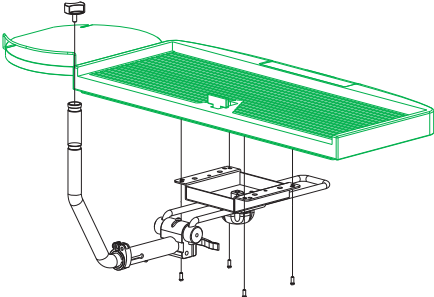
		#21-01 VESA 75 pivot bracket (max. load up to 24 lbs)
#21-01	#21-01H	#21-01H Heavy duty pivot bracket (VESA 75) (max. load up to 24-28 lbs.)
		#21-14 Fold up tray pivot unit
#21-02	#21-14	#21-02 VESA 75mm to VESA 100mm adaptor plate

Special tilt Pivot Bracket

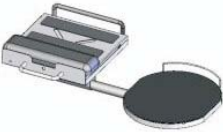
		#21-05-13 Drop Pin, 13" L (excluding #21-01 pivot head)
#21-05-13	#21-13	#21-13 LCD/Keyboard holder (excluding keyboard platform)

Platforms

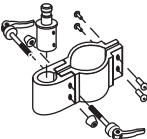
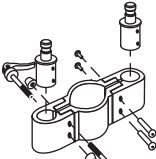

		#24-06 Clamp-Style Laptop Platform (#P-24-10 Optional mouse tray available)
#24-07	#24-31P	#24-07 Clamp-Style Keyboard Platform (Includes mouse tray & gel wrist rest)
		#24-21 Laptop platform, (15" W x 12" D)
#24-21	#24-06	#24-31P Phenolic Keyboard platform + mouse tray + gel wrist rest

Pole clamps





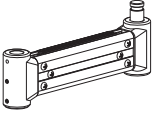
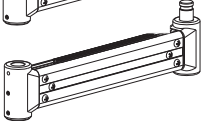
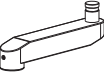



		#25-40Q Quick release 2" pole clamp
#25-40Q	#25-41Q	#25-41Q Quick release 2" dual mount pole clamp (back-to-back)
#25-42Q	#25-42Q	#25-42Q Quick release 1.5" pole clamp
	#25-43Q	#25-43Q Quick release lock 1.5" dual mount pole clamp (back-to-back)
	#25-42-SS	#25-42-SS Shim kit to reduce 25-42-Q bracket to 1"
	#25-43-SS	#25-43-SS Shim kit to reduce 25-43-Q bracket to 1"

Note: Shim kits available to adapt #25-40 & #25-41 to fit on CREFORM 28mm Tubing. Call CPS

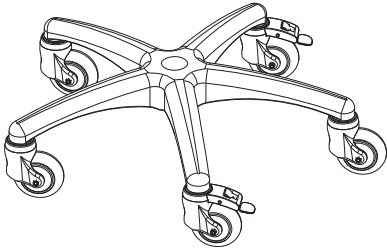
Part information

Parts	Part Numbers	Description
Extension Arms		
	#22-03-1	#22-03-1 Short extension arm (10")
	#22-03-2	#22-03-2 Long extension arm (18")
	#22-06-1	#22-06-1 Die cast extension arm (6 1/2")
2" Pole		
	#23-22	Dia. 2" pole x 16" long
	#23-23	Dia. 2" pole x 32" long
	#23-24	Dia. 2" pole x 48" long
	#23-72	Dia. 2" pole x 72" long (floor or ceiling mount)
16", 32" & 48" Long Poles Worksurface mount (Pole base ordered separately)	#23-26	2"/1.5" telescopic pole, height adjustment from 798mm to 1408mm
	#23-40	Pneumatic lift pole (used on 60251 mobile cart)
	#23-42	Pole base insert (used with 25-25 Round Pole base to mount 60272 Lockable arm to worksurface)
		
#23-26, Telescoping pole Ceiling mount (Pole base ordered separately)		

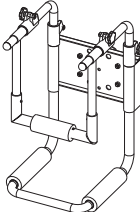
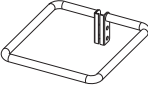
Part information

Parts	Part Numbers	Description
Pedestal mounts (for #23-13 telescoping pole)		
		#25-24 Die casting grommet for 23-13 telescoping pole
#25-36 U-Base	#25-24	#25-36 Free-Standing U-base (Shown with 23-13 telescoping pole)
2" pole base		
	#25-33 Round base for 2" pole (Screws are not included)	
#25-35 Heavy Duty round base for 2" pole (Screws are not included)		#25-34P Reinforced plastic mobile base (5 x 2" casters and 2 lockable)
		#25-34A Quality aluminum mobile base (5 x 4" wheels and 2 lockable)
#25-33	#25-35	
CPU/UPS holder/Cart handle/Cable Storage		
		#60606 Vertical surface mount adjustable CPU holder (wall/pole)
#60606	P60250-10	P60250-10 Mobile cart handle (to be mounted on any single pole mount bracket)
		60250 Mobile cart + 48" Pole (All other items shown are options)
#60251	#60250	60251 Mobile base with worksurface
		60250-13 Cable Storage Box (mounts on mobile cart pole to organize cables)

Part information

Parts

**Part
Numbers**

Description

Adjustable Arms

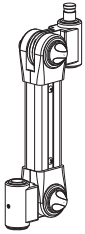

**#22-04
series**

**#22-04-3 Adjustable Arm, 15" L
(weight capacity 5.5-15 lbs.)**

**#22-04-5 Adjustable Arm, 15" L
(weight capacity 16-28 lbs.)**

Foldable arm

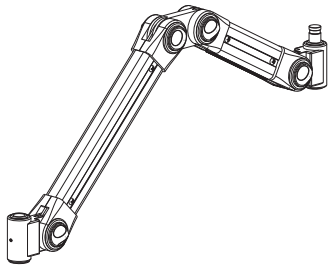

#26-31-52

**#26-31-52 Dual Adjustable Arm, 39 3/8" L
Wt. capacity: 2-11 lbs.**