



**Custom Products & Services, Inc.**

**6140 Claude Way E.**

**Inver Grove Heights, MN. 55076**

PH: 888-444-1202 (Toll Free) or 651-452-0113 FAX: 651-452-2264

E-MAIL: [info@custom-products.com](mailto:info@custom-products.com)

WEBSITE: [www.custom-products.com](http://www.custom-products.com)

*"Your source for workplace solutions"*

# ORDER GUIDE

## TRACK MOUNT SYSTEM



# Configurations

---

## TRACK MOUNT SERIES

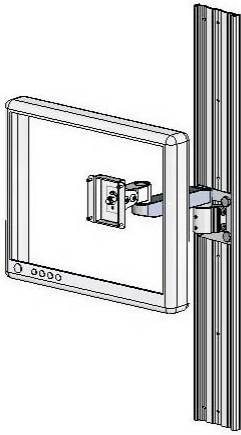

**#60221 LCD track mount**

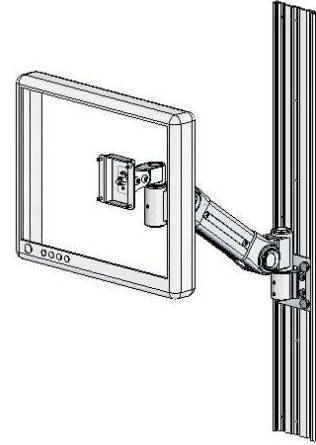

**#60212 Track mount LCD adjustable arm**

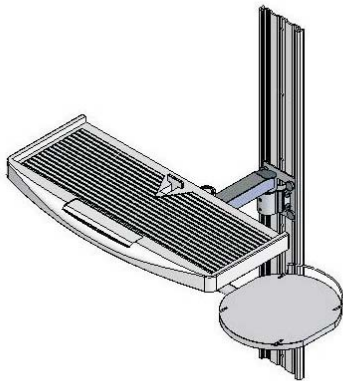

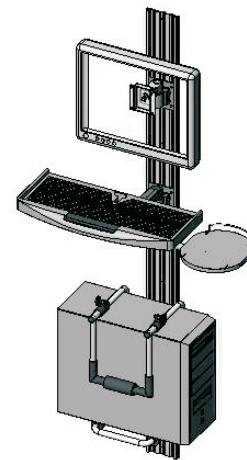

**#60218 keyboard holder track mount**







**Track mount LCD/KB/CPU total solution**







# Configurations

Configurations	Part Selections	Part Numbers	Descriptions
<b>Slim LCD track mount</b>  <b>#60260K Slim LCD track mount</b>	1. Sliding VESA adapter	#21-21-1B	VESA 75 track mount sliding adapter kit
	2. VESA conversion kit	#21-02	VESA 75 to VESA 100 conversion kit
	3. Sliding base	#25-50	Track mount sliding base
	4. Track	#25-50-13	Aluminum alloy extrusion track (32" long)
<b>Compact LCD track mount</b>  <b>#60216K Compact LCD track mount</b>	1. Pivot head	#21-01 #21-01H #21-21Q	VESA 75mm pivot bracket Heavy duty pivot bracket (VESA 75mm ) VESA 75 track mount quick release pivot adapter
	2. VESA adapter	#21-02	VESA 75 to VESA 100 adaptor plate
	3. Sliding base	#25-50	Track mount sliding base
 <b>#60216 Compact LCD track mount</b>	4. Track	#25-50-13	Aluminum alloy extrusion track (32" long)



# Configurations



Configurations	Part Selections	Part Numbers	Descriptions
<b>Track mount extended LCD</b>  #60215K track mount extended LCD arm	1. Pivot head	#21-01	VESA 75mm pivot bracket
		#21-01H	Heavy duty pivot bracket (VESA 75mm )
		#21-21-1B	VESA 75 track mount sliding adapter kit
		#21-21Q	VESA 75 track mount quick release pivot adapter
2. VESA adapter			#21-02 VESA 75 to VESA 100 adaptor plate
 #60215K track mount extended LCD arm	3. Extended arm	#22-03-1	Short extension arm (10" L)
		#22-03-2	Long extension arm (18", L)
		#22-06-1	Die casting swing arm (6 ½" L)
 #60212K track mount adjustable LCD arm	4. Adjustable arm	#22-04-3	Adjustable arm, 15" L / (5.5 - 15 lbs.)
		#22-04-5	Adjustable arm, 15" L / (16 - 28 lbs.)
 #60226K track mount foldable LCD arm	5. Foldable arm	#26-31-52	Dual Adjustable Arm, 39-3/8" L Weight capacity: 2-11 lbs.
6. Sliding base			#25-50 Track mount sliding base
 #60606K track mount CPU holder	7. CPU/UPS holder	#60606	Vertical surface mount CPU/UPS holder
8. Track			#25-50-13 Aluminum alloy extrusion track (32" long)

# Configurations

Track mount Configurations	Part Selections	Part Numbers	Descriptions
 <p>#60215K track mount compact keyboard arm</p>	<p>1. Tray pivot bracket</p>	#21-14	Fold up tray pivot unit
 <p>#60215K track mount compact keyboard arm</p>	<p>2. Platforms</p>	<p>#24-06 #24-07 #24-21 #24-31P #P24-12-10</p>	<p>Clamp-Style Laptop Platform + optional mouse tray Clamp-Style Keyboard Platform + Mouse Tray + gel wrist rest Laptop platform, (15" W x 12" D) Phenolic Keyboard platform + mouse tray + gel wrist rest Optional Mouse Tray for #24-06 &amp; #24-07</p>
 <p>#60218K track mount adjustable KB arm</p>	<p>3. Extension arms</p>	<p>#22-03-1 #22-03-2 #22-06-1</p>	<p>Short extension arm (10" L) Long extension arm (18" L) Die casting swing arm (6 ½" L)</p>
 <p>#60218K track mount extended keyboard arm</p>			
 <p>#60239-K track mount Extended LCD/KB</p>	<p>5. Sliding base</p>	#25-50	Track mount sliding base
 <p>#60239-K track mount Adjustable LCD/ KB</p>	<p>7. Track</p>	#25-50-13	Aluminum alloy extrusion track (32" long)

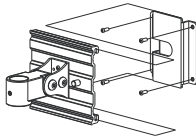
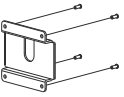
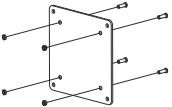
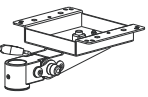
# Part information

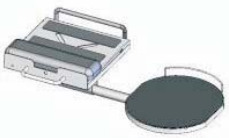
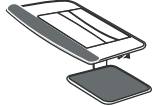
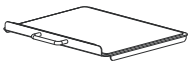
Parts	Part Numbers	Description
<b>Pivot Head &amp; VESA Adpater</b>		
	#21-01	VESA 75 pivot bracket (max. load up to 24 lbs.)
	#21-01H	Heavy duty pivot bracket (VESA 75) (max. load up to 28 lbs)
	#21-21-1B	VESA 75 track mount sliding adapter kit
	#21-21-1B	VESA 75 track mount quick release pivot adapter
	#21-02	VESA 75mm to VESA 100mm adaptor plate
	#21-14	Fold up tray pivot unit
	#21-21Q	VESA 75 track mount quick release pivot adapter (Available 6-2008)

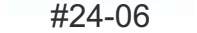
Platforms	Part Numbers	Description
	#24-06	Clamp-Style Laptop Platform + gel wrist rest + optional mouse tray
	#24-07	Clamp-Style Keyboard Platform + Mouse Tray + gel wrist rest
	#24-21	Laptop platform, (15" W x 12" D)
	#24-31P	Phenolic Keyboard platform + mouse tray + gel wrist rest
	#24-31P	Phenolic Keyboard platform + mouse tray + gel wrist rest
	#24-06	Clamp-Style Keyboard Platform + Mouse Tray + gel wrist rest

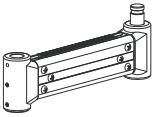
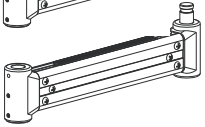
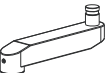
Extension Arms	Part Numbers	Description
	#22-03-1	Short extension arm (10")
	#22-03-2	Long extension arm (18")
	#22-06-1	Die casting swing arm (6 1/2")

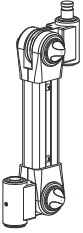
Adjustable Arms	Part Numbers	Description
	#22-04-3	Adjustable Arm, 15" L (weight capacity 5.5 - 15 lbs)
	#22-04-5	Adjustable Arm, 15" L (weight capacity 16-28 lbs.)
#22-04 series		

# Part information

---

Parts	Part Numbers	Description
-------	--------------	-------------

---

## Foldable arm

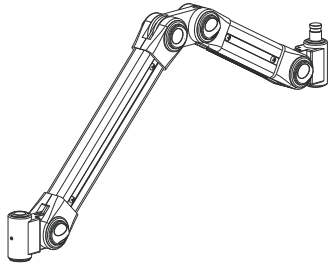

#26-31-52

#26-31-52 Dual Adjustable Arm, 39-3/8" L  
Weight capacity 2-11 lbs.

---

## Sliding Base

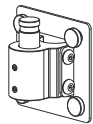

#25-50

#25-50 Track mount sliding base

---

## CPU/UPS holder

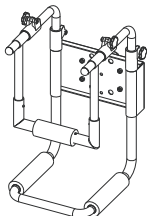

#60606

#60606 Vertical surface mount adjustable CPU holder(for pole/track/wall mount)

---

## Aluminum Track

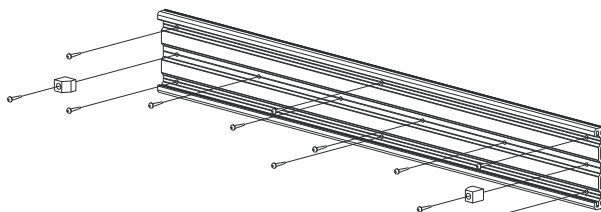

#25-50-13

#25-50-13 Aluminum extrusion track (32" long)