



Custom Products & Services, Inc.

6140 Claude Way E.

Inver Grove Heights, MN. 55076

PH: 888-444-1202 (Toll Free) or 651-452-0113 FAX: 651-452-2264

E-MAIL: info@custom-products.com
WEBSITE: www.custom-products.com



"Your source for workplace solutions"

ORDER GUIDE

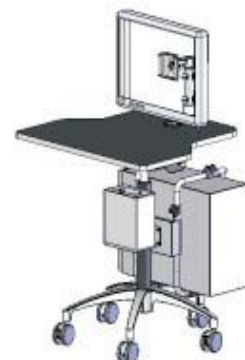



MOUNTS FOR LCD DISPLAYS, KEYBOARDS, LAPTOPS, CPU's

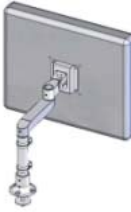

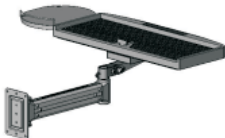

Configurations

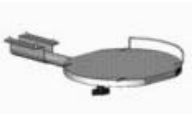
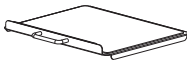
Configurations	Part Selections	Part Numbers	Descriptions
#60210 series Worksurface mount LCD arm 	1. Pivot Head	#21-01	VESA 75mm pivot bracket
		#21-01H	Heavy duty pivot bracket (VESA 75)
		#21-21Q	Track mount quick release pivot adapter
	2. Adjustable arm	#22-04-3	Adjustable Arm, (15" L) Wt. capacity: 5.5 lbs - 15 lbs.
#22-04-5		Adjustable Arm, (15"L) Wt. capacity: 16 lbs - 28 lbs.	
3. Extension arm	#22-06-1	Die cast extension arm (6 ½" L)	
4. Mount	#25-01-J	C-Clamp	
	#25-22	Grommet Pin	
#60212 series Vertical surface mount LCD arm 	1. Pivot Head	#21-01	VESA 75mm pivot bracket
		#21-01H	Heavy duty pivot bracket (VESA 75)
		#21-21Q	Track mount quick release pivot adapter
	2. Adjustable arm	#22-04-3	Adjustable Arm, (15" L) Wt. capacity: 5.5 lbs - 15 lbs.
#22-04-5		Adjustable Arm, (15"L) Wt. capacity: 16 lbs - 28 lbs.	
3. Extension arm	#22-06-1	Die cast extension arm, (6 ½" L)	
4. Mount (See Page 10)	#25-12	Wall mount bracket	
	#25-40Q	2" pole clamp (single mount)	
	#25-42Q	1- 1/2" pole clamp (single mount)	
#60216 Compact LCD arm 	1. Pivot Head	#21-01	VESA 75mm pivot bracket
		#21-01H	Heavy duty pivot bracket (VESA 75)
#21-21Q		Track mount quick release pivot adapter	
2. Mount (See Page 10)	#25-12	Wall mount bracket	
	#25-40Q	2" pole clamp (single mount)	
	#25-42Q	1 1/2" pole clamp (single mount)	
#60217 Series LCD Pedestal 	1. Pivot Head	#21-01	VESA 75mm pivot bracket
		#21-01H	Heavy duty pivot bracket (VESA 75)
		#21-21Q	Track mount quick release pivot adapter
	2. Telescopic pole	#23-13	Telescopic pole, height adjustment from 12 3/8" to 16 3/8"
3. Extension arm	#22-06-1	Die cast extension arm (6 ½" L)	
4. Mount (See Page 10)	#25-24	Die casting grommet for telescopic pole	

Configurations

Configurations	Part Selections	Part Numbers	Descriptions
#60218 Series Extended Holder  #24-31-P (shown)	1. Tray	#24-06	Laptop Clamp Platform (optional #P-24-12 mouse tray available)
		#24-07	New Keyboard Clamp (includes mouse tray& gel wrist rest)
		#24-21	Laptop platform (15"x12") (Optional Mouse Tray Available)
		#24-31P #P24-12-10 #P34MT	Phenolic Keyboard Platform + mouse tray + Vinyl wrist rest Optional Mouse Tray for use with #24-06 & #24-07 Optional Mouse Tray for 24-21 Laptop Platform
	2. Pivot Head	#21-14	Fold up tray pivot unit
	3. Extension Arm	#22-03-1	Short extension arm (10")
		#22-03-2	Long extension arm (18")
		#22-06-1	Die cast extension arm (6 1/2") * *(Not for use with Wall Mount Bracket)
	4. Mount (See Page 10)	#25-12	Wall mount bracket
		#25-40Q	2" pole clamp (single mount)
		#25-42Q	1 1/2" pole clamp (single mount)
			
#24-07	#24-06	#P24-12-10	#24-21
#60220 series Desk top mount LCD arm 	1. Pivot Head	#21-01	VESA 75mm pivot bracket
		#21-01H	Heavy duty pivot bracket (VESA 75)
		#21-21Q	Track mount quick release pivot adapter
		2. Adjustable arm	#22-04-3
	#22-04-5		Adjustable Arm, 15" L, Wt. capacity: 16-28 lbs
	3. Extension arm	#22-06-1	Die casting swing arm 165mm(6 1/2")
	4. Mount (See Page 10)	#25-22	Grommet Pin
		#25-25	Die casting grommet for adjustable arm
#60221 series Vertical surface mount swing arm 	1. Pivot Head	#21-01	VESA 75mm pivot bracket
		#21-01H	Heavy duty pivot bracket (VESA 75)
		#21-21Q	Track mount quick release pivot adapter
	2. Extended Arm	#22-03-1	Short extension arm (10")
		#22-03-2	Long extension arm (18")
	3. Mount (See Page 10)	#25-12	Wall mount bracket
		#25-42	1.5" pole mount bracket
		#25-40	2" pole mount bracket

Configurations

Configurations	Part Selections	Part Numbers	Descriptions
#60222 series Vertical surface mount 2-arm system 	1. Pivot Head	#21-01	VESA 75mm pivot bracket
		#21-01H	Heavy duty pivot bracket (VESA 75)
	#21-21Q	Track mount quick release pivot adapter	
	2. Extended Arm	#22-03-1	Short extension arm (10")
#22-03-2		Long extension arm (18")	
3. Adjustable Arm	#22-04-3	Adjustable Arm, 15" L, Wt. capacity: 5.5-15 lbs.	
	#22-04-5	Adjustable Arm, 15" L, Wt. capacity: 16-28 lbs.	
4. Mount (See Page 10)	#25-12	Wall mount bracket	
	#25-40Q	2" pole clamp (single mount)	
	#25-42Q	1 1/2" pole clamp (single mount)	
#60223 series Adjustable Platform 	1. Tray	#24-21	Laptop platform (15" W x 12" D)
		#24-06	Adjustable Clamp-Style Laptop Platform
		#P34MT	Optional Mouse Tray for #24-21 Laptop Platform
		#P24-12-10	Optional Mouse Tray for #24-06
	2. Pivot Head	#21-14	Fold up tray pivot bracket
3. Adjustable Arm	#22-04-3	Adjustable Arm, 15" L, Wt. capacity: 5.5-15 lbs.	
4. Extension arm	#22-06-1	Die cast swing arm, (6 1/2" L)	
5. Mounts (See Page 10)	#25-01-J	2 in 1 mount (C-Clamp)	
	#25-12	Wall mount bracket	
	#25-22	Grommet Pin	
#24-06	#P24-12-10	#24-21	
#60226 series Desk top mount Foldable arm 	1. Pivot Head	#21-01	VESA 75mm pivot bracket
		#21-01H	Heavy duty pivot bracket (VESA 75)
		#21-21Q	Track mount quick release pivot adapter
2. Foldable Arm	#26-31-52	Dual Adjustable Arm reach, 39" L, Wt. capacity: 4-11 lbs.	
3. Mount (See page 10)	#25-25	Die casting grommet for adjustable arm	
	#25-22	Grommet Pin	

Configurations

Configurations	Part Selections	Part Numbers	Descriptions
#60217 Series LCD Free stand 	1. Pivot Head	#21-01 #21-01H #21-21Q	VESA 75mm pivot bracket Heavy duty pivot bracket (VESA 75) Track mount quick release pivot adapter
	2. Telescopic pole	#23-13	Telescopic pole, height adjustment from (12 3/8") to (16 3/8")
	3. Base	#25-36	U-Base for 23-13 telescoping pole

Sold as complete assembly		
#60240C Series LCD Ceiling mount (May also be mounted to horizontal surface)	1. Tilt Pivot Head	VESA 75mm x 75mm
	2. Swivel Base	Lockable steel round base







#60240F Series FlexiStand



1. Pivot Head	VESA 75mm x 75mm
2. Swivel Base	Heavy free base

Configurations

Configurations	Part Selections	Part Numbers	Descriptions
#60226 series Wall or pole mount Foldable arm 	1. Pivot Head	#21-01	VESA 75mm pivot bracket
		#21-01H	Heavy duty pivot bracket (VESA 75)
		#21-21Q	Track mount quick release pivot adapter
	2. Foldable Arm	#26-31-52	Dual Adjustable Arm, 39-3/8" L Wt. capacity 2 - 11 lbs.
		#25-12	Wall mount bracket
		#25-40Q	2" pole clamp (single mount)
	3. Mount (See Page 10)	#25-42Q	1 1/2" pole clamp (single mount)
#60239 Series Adjustable LCD & KB holder  #24-07  #P24-12-10	1. Pivot Head	#21-01	VESA 75mm pivot bracket
		#21-01H	Heavy duty pivot bracket (VESA 75)
		#21-21Q	Track mount quick release pivot adapter
	2. Tray	#24-31P	Phenolic keyboard platform (Standard) (with mouse tray & vinyl wrist rest)
		#24-07	Adjustable Clamp-Style Keyboard Platform (Mouse tray ordered separately)
#P24-12-10		Optional Mouse Tray for #24-07	
3. Tilt Pivot Head	#21-13	Universal LCD/KB support pivot bracket	
4. Adjustable arm	#22-04-5	Adjustable Arm, 15" L. Wt. cap: 15-28 lbs.	
	5. Mount (See Page 10)	#25-12	Wall mount bracket
		#25-40Q	2" pole clamp (single mount)
		#25-42Q	1 1/2" pole clamp (single mount)
#60272 Series Lockable - Adjustable LCD Arm Wall, Pole or Worksurface mount 	1. Pivot Head	#21-01	VESA 75mm pivot bracket (included)
		#21-02	Adaptor Plate for 100 x 100 mm VESA
	2. Lockable Arm	#60272	Lockable, Adjustable Arm, 30" L Wt. capacity 5 - 18 lbs. (neutral balance) Arm Position: 45 deg (up) - 45 deg (down)
3. Mount		#25-49	Wall Mount Bracket (included)
	#25-35 / 23-42	Pole mount bracket for 2" dia. pole (only)	
		Round base and base insert (worksurface mount)	

Part information

Parts	Part Numbers	Description
-------	--------------	-------------

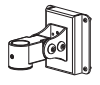
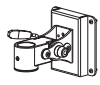
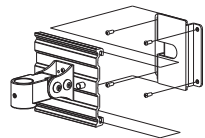
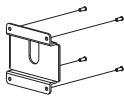
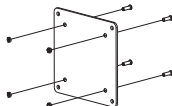
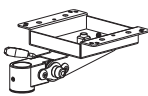

Pivot Brackets & Adaptor plates

			#21-01 VESA 75 pivot bracket (max. load up to 24 lbs)
#21-01	#21-01H	#21-21Q (Available 6-2008)	#21-01H Heavy duty pivot bracket (VESA 75) (For 24-28 lb. loads)
			#21-21 VESA 75 track mount sliding adaptor
			#21-21Q VESA 75 track mount quick release pivot bracket
#21-21	#21-02	#21-14	#21-02 VESA 75mm to VESA 100 mm adaptor plate
			#21-14 Fold up tray pivot unit

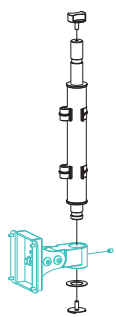
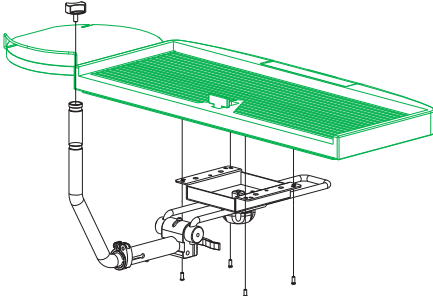
Tilt Pivot Bracket

		#21-05-13 Vertical Drop Pin, 13" L (#21-01 Pivot Bracket ordered separately)
#21-05-13	#21-13	#21-13 LCD/Keyboard holder (keyboard platform ordered separately)

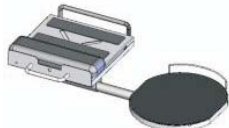
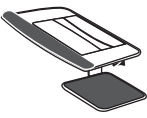
Platforms

		#24-06 Clamp-Style Laptop Platform (#P-24-12 Optional mouse tray available)
#24-07	#24-31P	#24-07 Clamp-Style Keyboard Platform + Mouse Tray (Includes Mouse Tray & gel wrist rest)
		#24-21 Laptop platform, (15" W x 12" D) (Optional Mouse Tray Available)
#24-21	#24-06	#24-31P Phenolic Keyboard platform + mouse tray + gel wrist rest

Part information

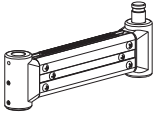
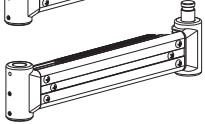
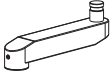
Parts	Part Numbers	Description
Extension Arms		
	#22-03-1	#22-03-1 Short extension arm (10")
	#22-03-2	#22-03-2 Long extension arm (18")
	#22-06-1	#22-06-1 Die cast extension arm (6 1/2")

Telescopic pole



#23-13

#23-13 Spring assisted telescopic pole with cable clips, height adjustment from 12 3/8"-16 3/8"

2" Pole



16", 32" & 48" Long Poles
Worksurface mount
(Pole base ordered separately)

#23-22 Dia. 2" pole x 16" long (worksurface mount)

#23-23 Dia. 2" pole x 32" long (worksurface mount)

#23-24 Dia. 2" pole x 48" long (worksurface mount)

#23-26 2"/1.5" telescopic pole, height adjustment from 31-1/2" - 55"
(ceiling mount)

#23-40 Pneumatic lift pole
(used on 60251 series mobile carts)



#23-26, Telescoping pole
Ceiling mount
(Pole base ordered separately)

#23-42 2" pole insert
(used with 25-33 or 25-35 round base to mount 60272 lockable arm to worksurface)

Part information

Parts	Part Numbers	Description
-------	--------------	-------------

Adjustable Arms

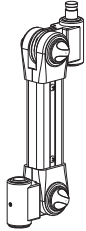

#22-04 series

#22-04-3 Adjustable Arm, 15" L
(weight capacity: 5.5-15 lbs)

#22-04-5 Adjustable Arm, 15" L
(weight capacity: 16 - 28 lbs.)

Foldable arm

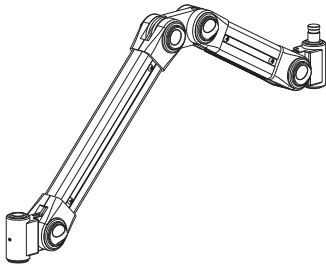



#26-31-52

#26-31-52 Dual adjustable Arm, 39-3/8" L
Wt. Capacity: 2-11 lbs.

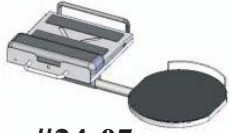

#60272 Lockable, Adjustable Arm
Wt. Capacity: 5-18 lbs.
Arm, Wall Bracket and pivot
bracket included

Part information

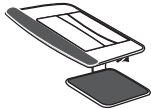
Parts	Part Numbers	Description
Holding platforms		
	#24-06	Clamp Style Laptop Platform (#P-24-12-10 Mouse Tray Available)
	#24-07	Keyboard Clamp (Includes Mouse Tray & Wrist Rest)
	#24-21	Laptop platform, 15" W x 12" D (Optional Mouse Tray available)
	#24-31P	Phenolic Keyboard platform + mouse tray + vinyl wrist rest
#P24-12-10		Optional mouse tray for #24-06 & #24-07)
#24-21		Optional mouse tray for 24-21 Laptop Platform

C-clamp mount

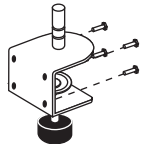

#25-01-J

#25-01-J 2 in 1 mount C-Clamp
(Concrete anchor Screws are included)

Desk top mounts



#25-22



#25-25

#25-22 Steel grommet mount

#25-25 Die casting grommet mount

Vertical surface mounts

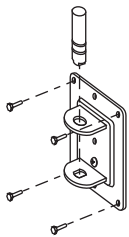

#25-12

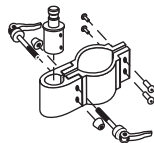

#25-40Q
#25-42Q

#25-12 Wall mount bracket
(concrete anchor screws are included)

#25-40Q Quick release 2" pole clamp

#25-41Q Quick release 2" dual mount
pole clamp (Back-to-back)

#25-42Q Quick release 1.5" pole clamp

#25-43Q Quick release lock 1.5" dual
mount pole clamp (Back-to-back)

#25-42-SS Shim kit to reduce 25-42-Q bracket to 1"

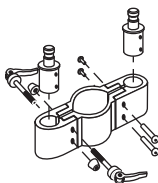

#25-43-SS Shim kit to reduce 25-43-Q bracket to 1"



#25-41Q
#25-43Q

Note: Shim kits available to adapt #25-40 & #25-41 to
fit on CREFORM 28mm Tubing. Call CPS

Part information

Parts	Part Numbers	Description
Pedestal mounts (for #23-13 pole)		
		
	#25-24	Die casting grommet for #23-13 telescoping pole
	#25-36	U-Base for #23-13 telescoping pole
25-36 U-Base (Shown with 21-12 Pole)		

2" pole base

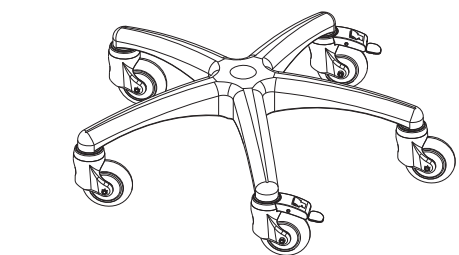

#25-34A

- #25-33 Round base for 2" pole
(Screws are not included)
- #25-35 Heavy Duty round base for 2" pole
(Screws are not included)
- #25-34P Reinforced plastic mobile base
(5 x 2" plastic casters and 2 lockable)
- #25-34A Quality aluminium mobile base
(5 x 4" Medical casters. 2 lockable)

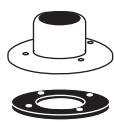

#25-33

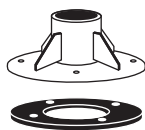

#25-35

CPU/UPS holder/Cart handle

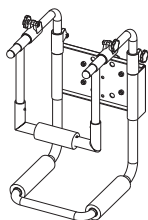

#60606

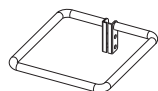

P60250-10

- #60606 Vertical surface mount adjustable CPU holder (wall/pole)
- P60250-10 Mobile cart handle (to be mounted on any single pole mount bracket)
- 60250 Mobile Cart (Caster base + 48" L Pole)
(All other items shown are accessories)
- 60251 Mobile cart with worksurface
- 60250-13 Cable Storage Box (mounts on mobile cart pole to organize cables)



#60251 Cart



#60250 Cart

Part information

Mobile Carts

Parts

**Part
Numbers**

Description



#60250

Mobile Plastic Base w/ 48" L Pole

Optional items (shown) include:

#21-01

LCD Pivot Bracket

#21-02

Adaptor Plate (100mm VESA)

#25-40

Single Pole Bracket for 2" pole

#22-06-1

Extension Arm, 6-1/2" L

#60606

CPU Holder

#60250

Pull Handle

Optional items available (not shown):

#60250-13

Cable Management Box

#24-21

Laptop Platform (12" x 15")

#24-06

Clamp-style laptop Platform

#60250-13

Cable storage box



#60251

Mobile Aluminum Base w/ 48" L Pole
MDF Worksurface, Telescoping lift
cylinder.

Optional items (shown) include:

#60217

LCD Mount w/ adjustable post

#21-02

Adaptor plate, 100mm VESA

#60606

CPU Holder

#60250-13

Cable Management Box